

**WIPCOOL**<sup>®</sup>

FEELING FOR MORE

**CONDENSATE PUMP P16/P32**

— OPERATION MANUAL —

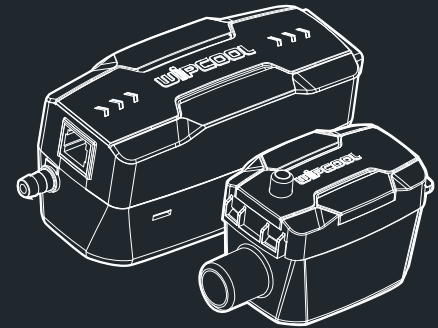

**WIPCOOL**<sup>®</sup>  
FEELING FOR MORE

[www.wipcool.com](http://www.wipcool.com)

Reliable And Durable,  
Silence Running



### 1. Explosion Diagram

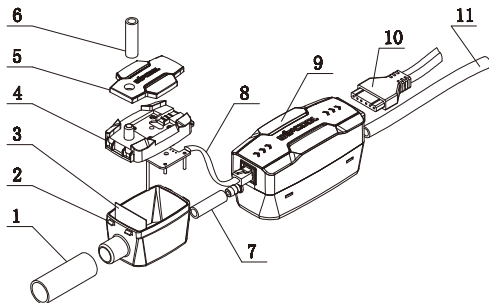

No.	Part Name	No.	Part Name	No.	Part Name
1	Water inlet pipe	5	Upper cover plate	9	Condensate pump assembly
2	Tank	6	Air hole( $\phi$ 6x20)	10	Power cord
3	Filter net	7	Water pipe( $\phi$ 6x1500)	11	Water outlet pipe
4	Upper cover	8	Induction signal line		

### 2. Dimension

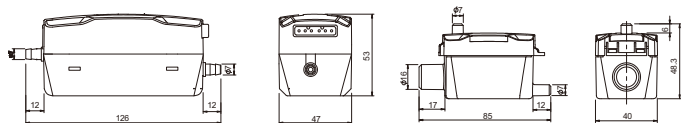

### 3. Technical Data

Model	P16	P32
Voltage	100V-230V~/50-60Hz	
Discharge head(Max.)	10m	
Flow rate(Max.)	16L/h(4.2GPH)	32L/h(8.5GPH)
Tank capacity	35ml	
Mini splits up to	30000btu/hr	45000btu/hr
Sound level at 1m	19dB(A)	21 dB(A)
Ambient temp.	0°C~50°C	





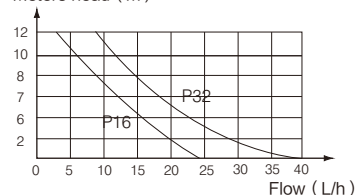

### 4. Flow Rate Chart

Meters head ( m )



Model	Performance(l/h@head)					
	0m	2m	4m	6m	8m	10m
P16	24	20	18	16	12	8
P32	40	36	26	22	18	14

## 5. Safety Instructions

-  1. Place the tank horizontal when installing, do not tilt the pump. Check whether the level drop is centered; if there is tilt, adjust the water level before using it.
-  2. Do not place electrical appliances or valuables under the condensate pump to avoid loss caused by power failure or water leakage.
-  3. Non - professional personnel should not install it to avoid danger.
-  4. The condensate pump is not waterproof. Do not place it in the open air, outdoors or in a place prone to flooding.
-  5. The condensate pump power supply needs to be independent to maintain permanent power supply. For details of connecting with air conditioning system, please refer to the wiring diagram.
-  6. It is prohibited that the water inflow is bigger than our stated flow rate, which will easily cause the motor to work continuously and fail. Instant big water inflow will also cause the condensate pump fail to discharge water in time, leading to water leakage.

## 6. Installation Procedure

- (1) Make sure the probe in the tank is on the right side of the filter net, the filter net and the upper cover are firmly mounted on the tank. (as shown below)

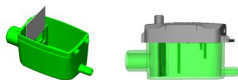

- (2) Make sure the tank is placed smoothly and the outlet pipe of the air conditioner is tightly connected with the water pipe of tank. (as shown below)

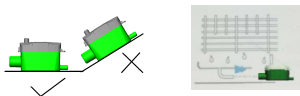

- (3) Connect the vent pipe with the air hole. (as shown below)



- (4) Place the pump in the position beyond the ceiling. (as shown below)

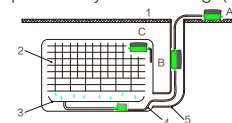

- (5) The use of shockproof materials, ensure the water tank and condensate pump stuck firmly, low vibration to avoid noise.



- (6) Pay attention to the direction of the water flow. (as shown below)



- (7) Connect the water tank and pump with 6x9 silicone tube and fasten it with tie, make sure the length of the water pipe is less than 2m ( as shown below )

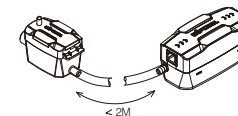

- (8) Connect the 6x9 water pipe to the water outlet, tie the water pipe, make sure that the discharge head is less than 8m and the length of the water pipe is less than 25m. ( as shown below )

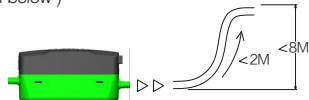

- (9) The condensate pump is equipped with work indicating light. When the pump is working normally, the green light is on. When the water level is in alarm, the red light is on. (as shown below)

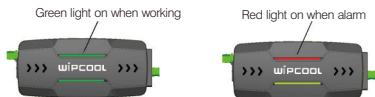

- (10) Power supply wiring, in order to avoid leakage of condensate pump, please connect the alarm signal line and the "Normally Closed" and "Normally Open" signal terminals according to the requirements of different working conditions (as shown below).

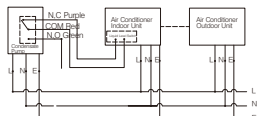

If the air conditioner does not have a liquid level switc, it can also connect to other alarm devices or refer to fig.

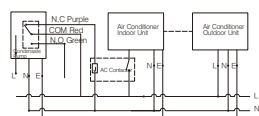

If there is no liquid level switch, it can also use an appropriate AC contactor to control the air conditioning power.

Power Cord: (L) Fire Wire: Brown (N) Zero Line: Blue (E) Ground Wire: Flower  
Signal Line: (NC) Normally Closed: Purple (COM) Common Line: Red  
(NO) Normally Open: Green

**WARNING**

Please pay attention to distinguish the power cord from the signal line, incorrect wiring will cause damage to the condensate pump. Ensure the voltage is consistent with pump.

- (11) Pour some water into the evaporator tray to check whether the tray leaks and the condensate pump works normally.



**7. Troubleshooting**

Problem	Cause	Action
Pump runs all the time	1. Installation is not horizontal	Adjust the tank make it level
	2. There is sludge inside tank	Clean the inside of tank and probe surface
Pump makes loud noise	1. The water is siphoning back in the pump	Check whether the outlet pipe is lower than pump thus result in siphoning, raise the condensate pump position
Pump can't start working	1. Installation is not horizontal	1. Adjust the tank, check water level
	2. The power can't reach pump	2. Check power supply
	3. The voltage isn't correct	3. Check the voltage

Note: Proper use and maintenance can improve the life of pump. We suggest to check and clean the condensate pump before seasons changing or next year using.