



Acvatix™

## 3-port seat valves with externally threaded connection, PN 16

## VXG41..

- Bronze CuSn5Zn5Pb2 valve body
- DN 15...50
- $k_{vs}$  1.6...40 m<sup>3</sup>/h
- Flat sealing connections with external thread G...B to ISO 228-1
- Sets of ALG..3 threaded fittings with threaded connection available from Siemens
- Can be equipped with SAX.. electromotoric or SKD.. and SKB.. electrohydraulic actuators
- VXG41..01 3-port seat valves are DVGW tested



### Use

For use in heating, ventilating and air conditioning systems as a control valve for mixing and diverting functions. For closed and open circuits (mind «cavitation» on page 5).  
VXG41..01 Three-port seat valves for distribution or supply of cold water to storage or heat exchanger for hot water treatment in the drinking water installation.

## Type summary

Type / stock no.		DN	$k_{vs}$ [m <sup>3</sup> /h]	$S_v$
	VXG41.1301 <sup>1)</sup>	15	1,6	> 50
	VXG41.1401 <sup>1)</sup>		2,5	
VXG41.15	VXG41.1501 <sup>1)</sup>		4,0	
VXG41.20	VXG41.2001 <sup>1)</sup>	20	6,3	> 100
VXG41.25	VXG41.2501 <sup>1)</sup>	25	10	
VXG41.32	VXG41.3201 <sup>1)</sup>	32	16	
VXG41.40	VXG41.4001 <sup>1)</sup>	40	25	
VXG41.50	VXG41.5001 <sup>1)</sup>	50	40	

<sup>1)</sup> These types, as a standard, are equipped with a tight bypass. DVGW verified, DVGW applications according to drinking water regulation 2001. For medium temperatures up to 90 °C

DN = Nominal size

$k_{vs}$  = Nominal flow rate of cold water (5...30 °C) through the fully open valve ( $H_{100}$ ) by a differential pressure of 100 kPa (1 bar)

$S_v$  = Rangeability  $k_{vs} / k_{vr}$

$k_{vr}$  = Smallest  $k_v$  value, at which the flow characteristic tolerances can still be maintained, by a differential pressure of 100 kPa (1 bar)

## Accessories

Type	Stock No.	Description
ALG..3 <sup>1)</sup>	ALG..3	Set of 3 threaded fittings for 3-port valves, consisting of - 3 union nuts, 3 discs and 3 flat seals ALG..3B are brass fittings, for media temperatures up to 100 °C.
ALG..3B <sup>1)</sup>	S55846-Z1..	
ASZ6.6	S55845-Z108	Electric stem heating element, AC 24 V 30 W, required for media below 0 °C

<sup>1)</sup> Applications requiring union fittings with DVGW approval must be delivered by thirds.

## Order

When ordering please give type, stock no., designation and quantity.

Example:

Type	Stock no.	Designation	Quantity
VXG41.2501	VXG41.2501	Valve	2
ALG253B	S55846-Z105	Set of threaded fittings	2

## Delivery

Valves, actuators and accessories are packed and supplied separately.

## Spare parts, rev. no.

See overview, page 10.

## Equipment combinations

Valves		Actuators						Fitting sets		
		SAX.. <sup>4)</sup>		SKD.. <sup>1)</sup>		SKB..		Malleable cast iron	Brass <sup>5)</sup>	
		Mixing	Diverting	Mixing	Diverting	Mixing	Diverting		Type / stock no.	Type
		$\Delta p_{max}$								
	VXG41.1301 <sup>3)</sup>	800	200 <sup>2)</sup>	800	200 <sup>2)</sup>	800	200 <sup>2)</sup>	ALG153	ALG153B	S55846-Z101
	VXG41.1401 <sup>3)</sup>									
VXG41.15	VXG41.1501									
VXG41.20	VXG41.2001									
VXG41.25	VXG41.2501									
VXG41.32	VXG41.3201									
VXG41.40	VXG41.4001	525	150 <sup>2)</sup>	775	150 <sup>2)</sup>		150 <sup>2)</sup>	ALG403	ALG403B	S55846-Z109
VXG41.50	VXG41.5001	300	100 <sup>2)</sup>	450	100 <sup>2)</sup>		100 <sup>2)</sup>	ALG503	ALG503B	S55846-Z111

<sup>1)</sup> Usable up to maximum medium temperature of 150 °C

<sup>2)</sup> If noise is permitted, the same values apply as for the mixing valve.

<sup>3)</sup> Use the valves in conjunction with actuators SKD.. or SKB.. to ensure compliance with the bypass leakage rate.

<sup>4)</sup> Series G / H: Usable up to maximum medium temperature of 130 °C

<sup>5)</sup> Usable up to maximum medium temperature of 100 °C

$\Delta p_{max}$  = Maximum permissible differential pressure across valve's control path, valid for the entire actuating range of the motorized valve

## Actuator overview

Type	Actuator type	Operating voltage	Positioning signal	Spring return	Positioning time	Positioning force	Data sheet	
SAX31.00	Electro-motoric	AC 230 V	3-position	No	120 s	800 N	N4501	
SAX31.03					30 s			
SAX81.00		AC/DC 24 V			120 s			
SAX81.03					DC 0...10 V <sup>1)</sup>			30 s
SAX61.03								
SKD32.50	Electro-hydraulic	AC 230 V	3-position	No	120 s	1000 N	N4563	
SKD32.21				Yes	30 s			
SKD32.51				No	120 s			
SKD82.50		Yes						
SKD82.51		AC 24 V		DC 0...10 V <sup>1)</sup>	No			30 s
SKD60					Yes			
SKD62..								
SKB32.50	Electro-hydraulic	AC 230 V	3-position	No	120 s	2800 N	N4564	
SKB32.51				Yes				
SKB82.50		AC 24 V		No				
SKB82.51				Yes				
SKB60				DC 0...10 V <sup>1)</sup>				No
SKB62..		Yes						

Actuators SAX81.. and SAX61.. are UL listed

<sup>1)</sup> or DC 4...20 mA or 0...1000  $\Omega$

Valve cross section

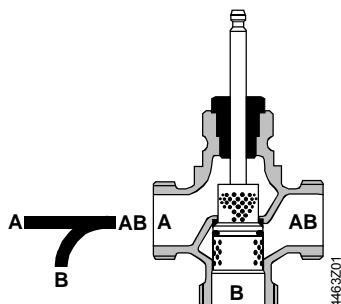

Guided perforated plug which is integrated in the valve stem.

A pressed-in stainless steel seat ring is used as seat A – AB.

Sizing

Flow diagram  
«Mixing»

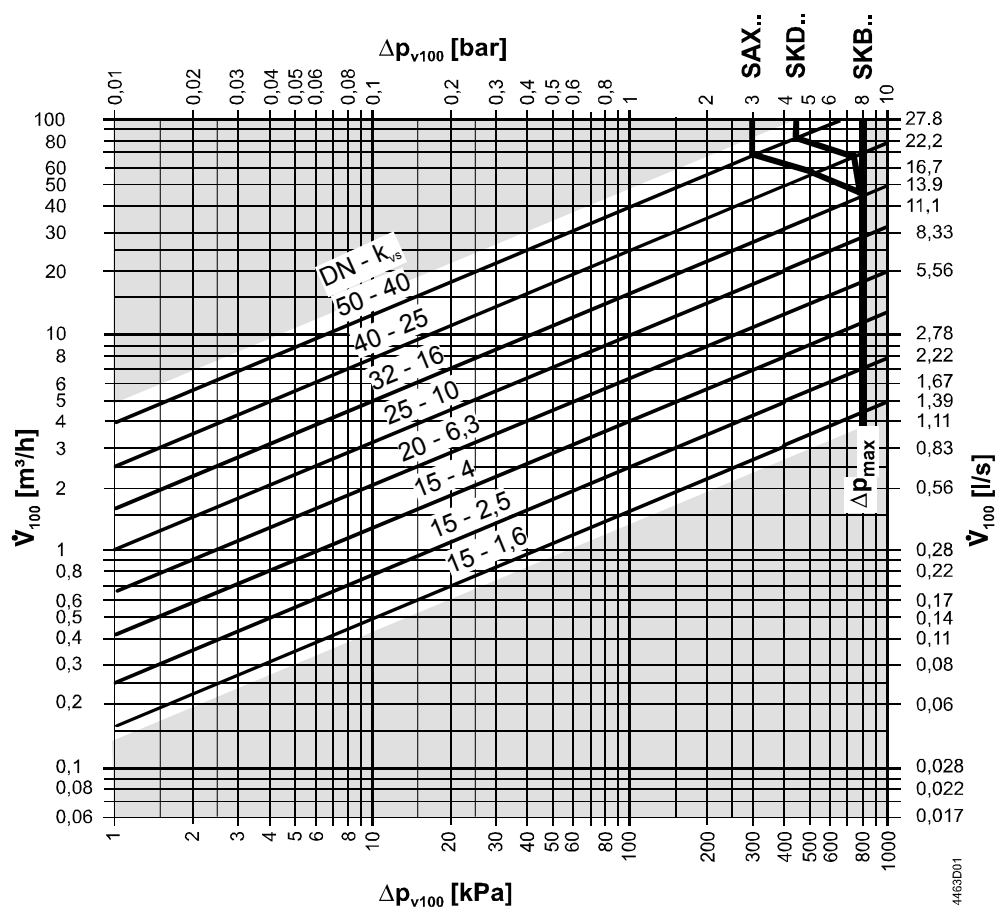

$\Delta p_{max}$  = Maximum permissible differential pressure across the valve (mixing: port A - AB, B - AB), valid for the entire actuating range of the motorized valve

$\Delta p_{v100}$  = Differential pressure across the fully open valve and the valve's control path A – AB, B - AB by a volume flow  $V_{100}$

$\dot{V}_{100}$  = Volume flow through the fully open valve ( $H_{100}$ )

100 kPa = 1 bar  $\approx$  10 mWC

1 m<sup>3</sup>/h = 0.278 l/s water at 20 °C

**Valve flow characteristic**

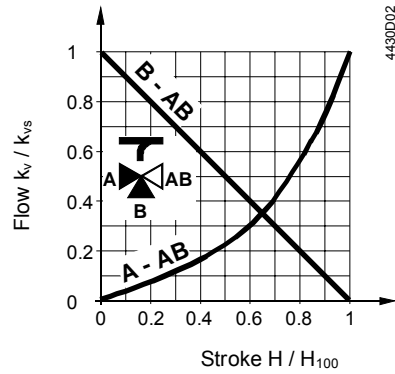

**Throughport**

0 ...30 %: linear  
 30 ...100 %: equal-percentage  $n_{gl} = 3$  to VDI / VDE 2173

**Bypass**

0...100 %: linear

**Mixing:** flow from port A and port B to port AB

**Diverting:** flow from port AB to port A and port B

Port I = constant flow

Port II = variable flow

Port III = bypass (variable flow)

Use the 3-port valve primarily as a mixing valve.

**Cavitation**

Cavitation accelerates wear on the valve plug and seat, and also results in undesirable noise. Cavitation can be avoided by not exceeding the differential pressure shown in the flow diagram on page 4, and by adhering to the static pressures shown below.

**Note on chilled water**

To avoid cavitation in chilled water circuits ensure sufficient counter pressure at valve outlet, e.g. by a throttling valve after the heat exchanger. Select the pressure drop across the valve at maximum according to the 80 °C curve in the flow diagram below.

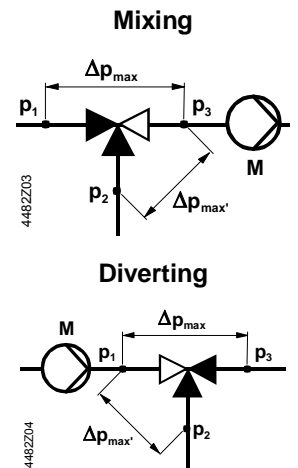
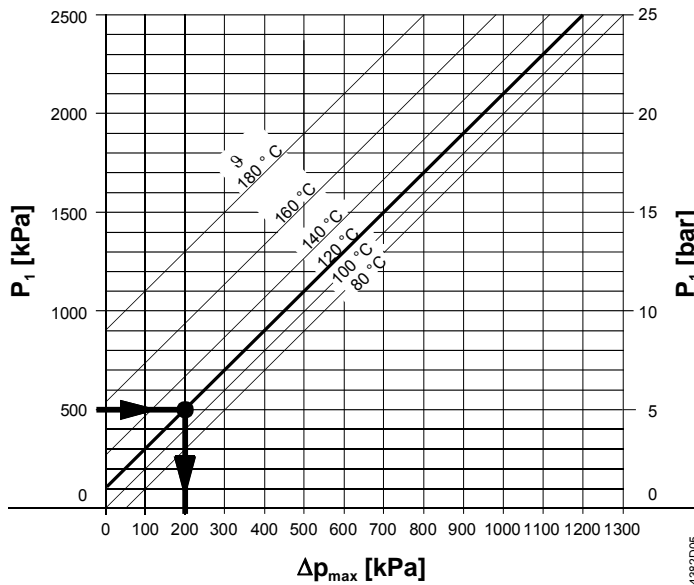

- $\Delta p_{max}$  = Differential pressure with valve almost closed, at which cavitation can largely be avoided
- ... Situation for bypass
- $p_1$  = Static pressure at inlet
- $p_2$  = Static pressure at outlet
- M = Pump
- $\vartheta$  = Water temperature

**High temperature hot water example:**

Pressure  $p_1$  at valve inlet: 500 kPa (5 bar)  
 Water temperature: 120 °C

From the diagram above, it will be seen that with the valve almost closed, the maximum permissible differential pressure  $\Delta p_{max}$  is 200 kPa (2 bar).

## Working pressure and temperature

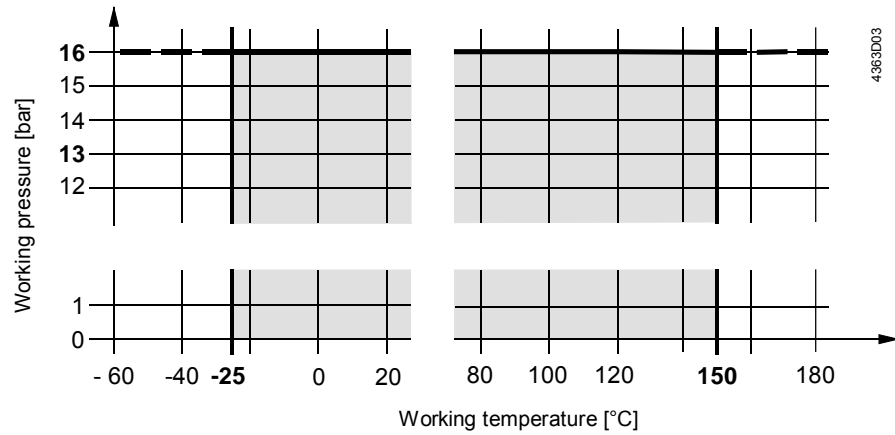

## Working pressure and medium temperature staged as per ISO 7005

Current local legislation must be observed.

## Notes

### Engineering



In open circuits, there is a risk of valve plug seizing caused by scale deposits. Thus, use only the most powerful actuator SKB.. for these applications. Additionally, periodic actuation (twice or three times per week) must be planned.  
With closed and open circuits always use a strainer upstream of the valve to increase the valve's functional safety.

Ensure cavitation-free flow, refer to page 5.

To ensure the reliability of the valve, we recommend the fitting of a strainer at the valve inlet in closed and open circuits.



For media below 0 °C, use the electric stem heating element to prevent the valve stem from freezing in the stem sealing gland. For safety reasons, the stem heating element has been designed for AC 24 V / 30 W operating voltage.

### Mounting

Both valve and actuator can easily be assembled at the mounting location. Neither special tools nor adjustments are required.

The valve is supplied with Mounting Instructions 4 319 9563 0.

### Orientation

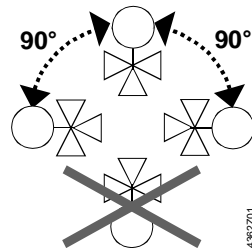

### Direction of flow

When mounting, pay attention to the valve's flow direction symbol →:

Mixing from  
A / B to AB

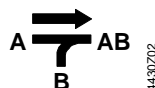

4430Z02

Diverting from  
AB to A / B

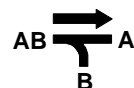

4430Z03

### Commissioning



**Commission the valve only if the actuator has been mounted correctly.**

Valve stem retracts: Throughport A – AB opens, bypass B closes

Valve stem extends: Throughport A – AB closes, bypass B opens

## Maintenance

---

Valves are equipped with maintenance-free, continuously lubricated stem sealing glands. See page 10 for replacement stem sealing glands.

### Warning

When doing service work on the valve / actuator:

- Deactivate the pump and turn off the power supply
- Close the shutoff valves
- Fully reduce the pressure in the piping system and allow pipes to completely cool down

If necessary, disconnect the electrical wires.

Before putting the valve into operation again, make certain the actuator is correctly fitted.

### Stem sealing gland

The glands can be exchanged without removing the valve, provided the pipes are depressurized and cooled off and the stem surface is unharmed, refer to «spare parts», page 10.

If the stem is damaged in the gland range, replace the entire valve.

Contact your local office or branch.

### Disposal

Do not dispose of the device as household waste.

- Special handling of individual components may be mandated by law or make ecological sense.
- Observe all local and currently applicable laws and regulations.

## Warranty

---

The technical data given for these applications is valid only in conjunction with the Siemens actuators as detailed under «Equipment combinations», page 3.

All terms of the warranty will be invalidated by the use of actuators from other manufacturers.

## Technical data

Functional data	PN class	PN 16 to ISO 7268
	Operating pressure	to ISO 7005 within the permissible medium temperature range according to the diagram on page 6
	Flow characteristic	
	• Throughport 0...30 %	• linear
	• Throughport 30...100 %	• equal percentage; $n_{gl} = 3$ to VDI / VDE 2173
	• Bypass 0...100%	• linear
	Leakage rate • Throughport	0...0.02 % of $k_{vs}$ value to DIN EN 1349
	• Bypass standard version	0.5...2% of $k_{vs}$ value
	• Bypass VXG41..01	0...0.02% of $k_{vs}$ value
	Permissible media water	cooling water, chilled water, low temperature hot water, high temperature hot water, water with anti-freeze; recommendation: water treatment to VDI 2035
drinking water	VXG41..01, < 90 °C	
Medium temperature <sup>1)</sup>	-25...150 °C	
DVGW applications, VXG41..01, chilled- and low temperature hot water	max. 90 °C	
Rangeability $S_v$	DN 15: > 50 DN ≥20: >100	
Nominal stroke	20 mm	
Standards, directives and approvals	Pressure Equipment Directive Pressure Accessories	PED 2014/68/EU Scope: Article 1, section 1 Definitions: Article 2, section 5
	Fluid group 2	without CE-marking as per article 4, section 3 (sound engineering practice) <sup>2)</sup>
	DVGW approval No.	DW-6341BU0025
	EAC Conformity	Eurasia Conformity
Environmental compatibility	The product environmental declaration CE1E4363en <sup>3)</sup> contains data on environmentally compatible product design and assessments (RoHS compliance, materials composition, packaging, environmental benefit, disposal).	
Materials	Valve body	bronze CuSn5Zn5Pb2
	Seat, plug, stem	stainless steel
	Stem sealing gland	dezincification-free brass EPDM O rings, silicon-free
Dimensions / Weight	Refer to «Dimensions»	
	External thread connections	G..B to ISO 228-1
	<sup>1)</sup> Media below 0 °C: Stem heating element required to prevent freezing of the valve stem in the stem sealing gland. Applications requiring union fittings with DVGW approval must be delivered by thirds.	
	<sup>2)</sup> Valves where $PS \times DN < 1000$ , do not require special testing and cannot carry the CE label.	
	<sup>3)</sup> The documents can be downloaded from <a href="http://siemens.com/bt/download">http://siemens.com/bt/download</a> .	



## Dimensions

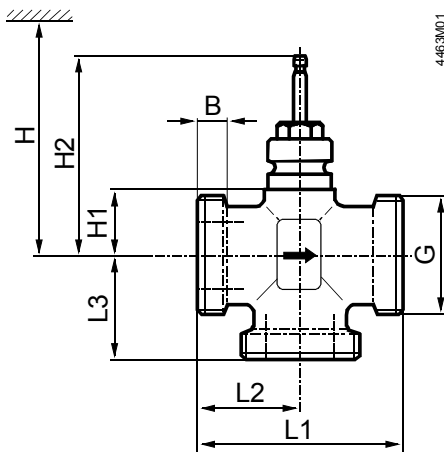

DN = Nominal size

H = Total actuator height plus minimum distance to the wall or the ceiling for mounting, connection, operation, service, etc.

H1 = Dimension from the pipe centre to install the actuator (upper edge)

H2 = Valve in the «Closed» position means that the stem is fully extended

Type	DN	B [mm]	G [inch]	L1 [mm]	L2 [mm]	L3 [mm]	H1 [mm]	H2 [mm]	H			[kg]
									SAX..	SKD..	SKB..	
VXG41.1301	15	10	G1B	100	50	50	26	122.5	> 468	> 526	> 601	1.30
VXG41.1401												
VXG41.15 VXG41.1501	20	10	G1¼B	100	50	50	26	122.5	> 468	> 526	> 601	1.42
VXG41.20 VXG41.2001												
VXG41.25 VXG41.2501	25	14	G1½B	105	52.5	52.5	34	130.5	> 476	> 534	> 609	1.65
VXG41.32 VXG41.3201	32		G2B									2.10
VXG41.40 VXG41.4001	40	15	G2¼B	130	65	65	46	142.5	> 488	> 546	> 621	2.80
VXG41.50 VXG41.5001	50	16	G2¾B	150	75	75						3.90

## Threaded fittings

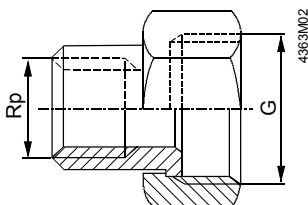

Malleable cast iron fittings Type / Stock No.	Brass fittings Type	Stock No.	for valve type	G [inch]	Rp [inch]
ALG153	ALG153B	S55846-Z101	VXG41.13...15	G 1	Rp ½
ALG203	ALG203B	S55846-Z103	VXG41.20..	G 1¼	Rp ¾
ALG253	ALG253B	S55846-Z105	VXG41.25..	G 1½	Rp 1
ALG323	ALG323B	S55846-Z107	VXG41.32..	G 2	Rp 1¼
ALG403	ALG403B	S55846-Z109	VXG41.40..	G 2¼	Rp 1½
ALG503	ALG503B	S55846-Z111	VXG41.50..	G 2¾	Rp 2

- On valve side: cylindrical thread to ISO 228-1
- On pipe side: with cylindrical thread to ISO 7-1
- For drinking water applications according to DVGW drinking water regulation 2001 threaded fittings must be obtained from local dealer.
- ALG..B for media temperatures up to 100 °C
- Applications requiring union fittings with DVGW approval must be delivered by thirds.

## Spare parts

### Order numbers for spare parts

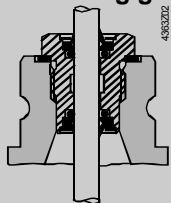
Type	DN	Stem sealing gland 
VXG41.1301	15	74 284 0047 0
VXG41.1401	15	74 284 0047 0
VXG41.15	15	4 284 8874 0
VXG41.1501	15	74 284 0047 0
VXG41.20	20	4 284 8874 0
VXG41.2001	20	74 284 0047 0
VXG41.25	25	4 284 8874 0
VXG41.2501	25	74 284 0047 0
VXG41.32	32	4 284 8874 0
VXG41.3201	32	74 284 0047 0
VXG41.40	40	4 284 8874 0
VXG41.4001	40	74 284 0047 0
VXG41.50	50	4 284 8874 0
VXG41.5001	50	74 284 0047 0

### Revision numbers

Type	Valid from rev. no.	Type	Valid from rev. no.	Type	Valid from rev. no.
VXG41.1301	..B	VXG41.2001	..B	VXG41.40	..A
VXG41.1401	..B	VXG41.25	..A	VXG41.4001	..B
VXG41.15	..A	VXG41.2501	..B	VXG41.50	..A
VXG41.1501	..B	VXG41.32	..A	VXG41.5001	..B
VXG41.20	..A	VXG41.3201	..B		

Issued by  
Siemens Switzerland Ltd  
Building Technologies Division  
International Headquarters  
Gubelstrasse 22  
6301 Zug  
Switzerland  
Tel. +41 41-724 24 24  
[www.siemens.com/buildingtechnologies](http://www.siemens.com/buildingtechnologies)

© Siemens Switzerland Ltd, 1998  
Technical specifications and availability subject to change without notice.